

COLONNA / TOWER

BRIDGE Y



Immagine dimostrativa

<http://www.globalfountain.it/colonne-spillatura-bevande.html>

Altre finiture disponibili su richiesta, tempi di consegna da concordare/ other types of finishings available on request, delivery times to be agreed

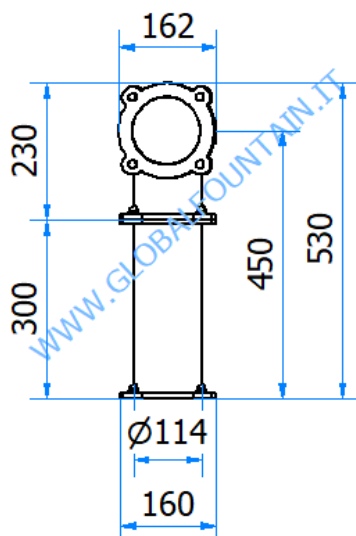

06000596 – BRIDGE 12P

DATI TECNICI / TECHNICAL DATA

VERSIONE / VERSION	BIRRA VINO PRE-MIX / BEER WINE PRE-MIX
VIE / PRODUCTS	12P SENZA RUBINETTO/WITHOUT TAP
FINITURA / FINISH	INOX LUCIDO / POLISHED STAINLESS STEEL
CORPO/BODY	ACCIAIO INOX / STAINLESS STEEL
TUBO PRODOTTO / PRODUCT LINE	5/16
RICIRCOLO / RECIRCULATION	3/8 – 5/16 – 1/2
DIMENSIONI / SIZE	L2010 P162 H530
PESO / WEIGHT	-
DIMENSIONI IMBALLO / PACKAGE DIMENSIONING	-
PESO LORDO/ GROSS WEIGHT	-
FISSAGGIO / FIXING	KIT TIRANTI / KIT BOLTS - 06000214
BOCCOLA RUB. / TAP FITTING	5/8 or 1/2
ILLUMINAZIONE/ILLUMINATION	-

COLONNA / TOWER

BRIDGE Y

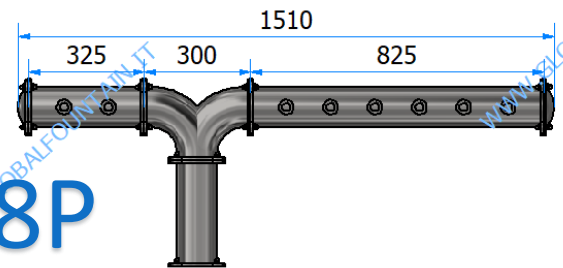
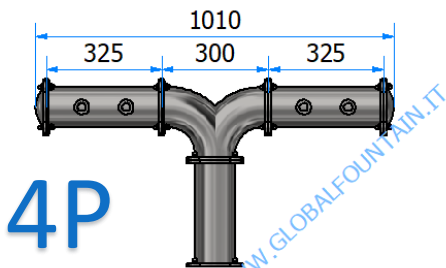
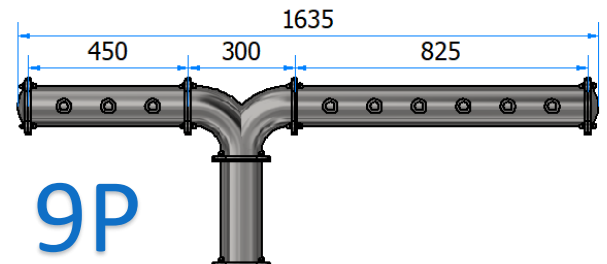
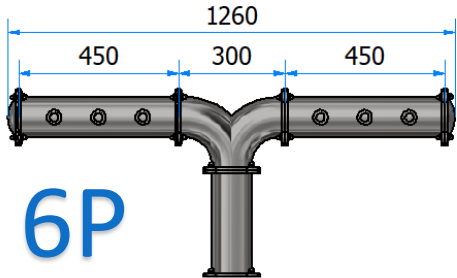
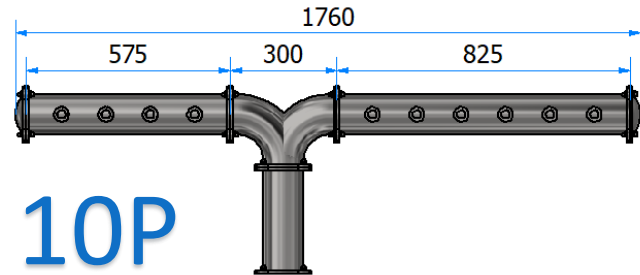
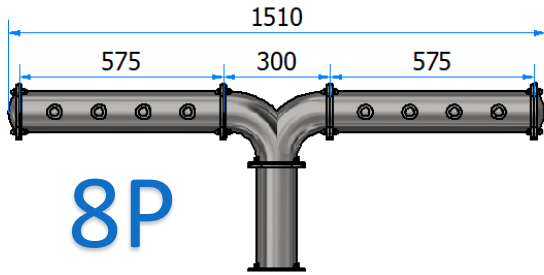
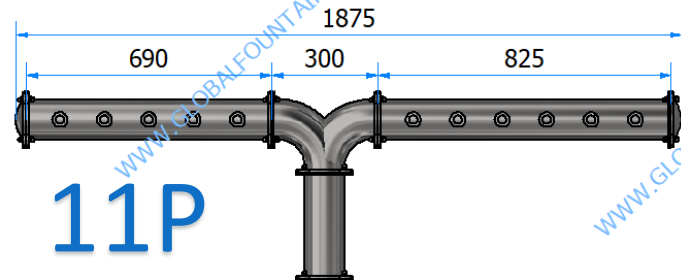
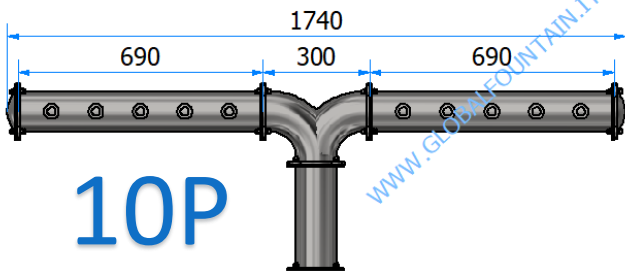
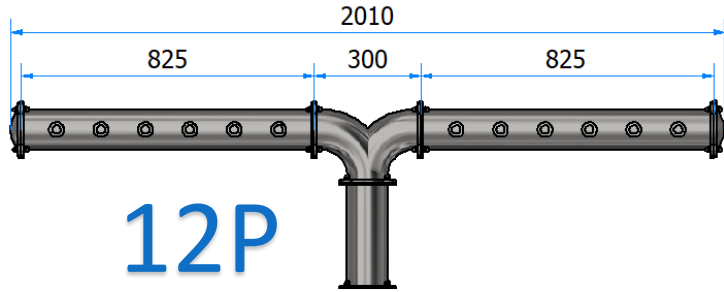

BRIDGE Y REGULAR		BRIDGE Y DISASSATA	
06000596	12P 6+6 L 2010 mm	06000601	11P 5+6 L 1875 mm
06000597	10P 5+5 L 1740 mm	06000602	10P 4+6 L 1760mm
06000598	8P 4+4 L 1510 mm	06000603	9P 3+6 L 1635 mm
06000599	6P 3+3 L 1260 mm	06000604	8P 2+6 L 1510 mm
06000600	4P 2+2 L 1010 mm		